



**JDV
CONTROL
VALVES**

JEW/JEV Series

Pneumatic Actuator



Overview

JEW / JEV Series pneumatic actuators are engineered for automated valve control applications requiring precision, durability, and international compatibility. Designed with an advanced rack-and-pinion mechanism, the actuators deliver stable torque output, accurate positioning, and long service life under high-cycle operations.

The series fully complies with global mounting and interface standards including ISO 5211, DIN 3337, and VDI / VDE 3845, ensuring seamless integration with quarter-turn valves, solenoid valves, switch boxes, and other NAMUR accessories. This standardized platform enables fast installation, interchangeability, and reduced system downtime.

Manufactured under ISO 9001 quality management procedures, each actuator undergoes functional testing and inspection to ensure performance reliability and traceability. The corrosion-protected extruded aluminum body, precision gearing, and multi-bearing guidance system support operation across a pressure range of 2.5 to 8 bar. Optional seals and stainless-steel shafts allow use in extreme temperature or corrosive environments.

Product Features

1. High-Reliability Structural Design

- Blowout-proof pinion shaft
- Multi-bearing and guiding support
- High cycle life construction

2. Precision Rack & Pinion Transmission

- High-precision machined tooth profile
- Low Backlash
- High torque output efficiency

3. Dual Piston Symmetrical Design

- Compact dimensional design
- Balanced torque output
- On-site reverse rotation capability
- Enhanced installation flexibility

4. Modular Spring Cartridge System

- Pre-compressed spring cartridges
- Rapid assembly / replacement
- Multiple torque level options
- Improved safety and corrosion resistance

5. Extruded Aluminum Body with Protection

- Internal and external anti-corrosion treatment
- Precision honed cylinder bore
- Low friction coefficient
- Extended seal life

6. International Mounting Compliance

Full compliance with:

- ISO 5211
- DIN 3337
- VDI / VDE 3845

Advantages:

- Rapid valve mounting
- Direct mounting of solenoid valves / limit switches
- Global accessory compatibility

7. Multifunction Position Indication System

- Visual open/close display
- NAMUR sensor mounting
- Low-cost automation integration
- Rapid field identification
- Precise valve position control
- Suitable for high-cycle operational valves

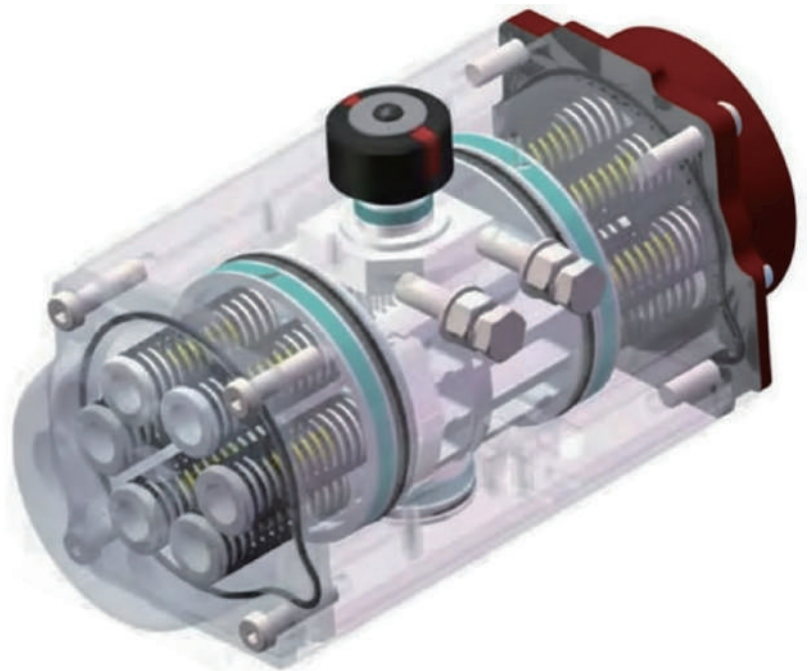

Technical Specifications

- Actuator Type: Double Acting / Spring Return
- Rotation Angle: 90° ($\pm 4^\circ$ adjustable)
- Air Supply Pressure: 2.5 – 8 Bar
- Mounting Standard: ISO 5211 / NAMUR
- Body Material: Extruded Aluminum Alloy
- Shaft Material: Carbon Steel / SS304 / SS316
- Temperature Range: $-20^\circ\text{C} \sim +80^\circ\text{C}^*$

*Optional seals available for extended ranges

Parts and Materials

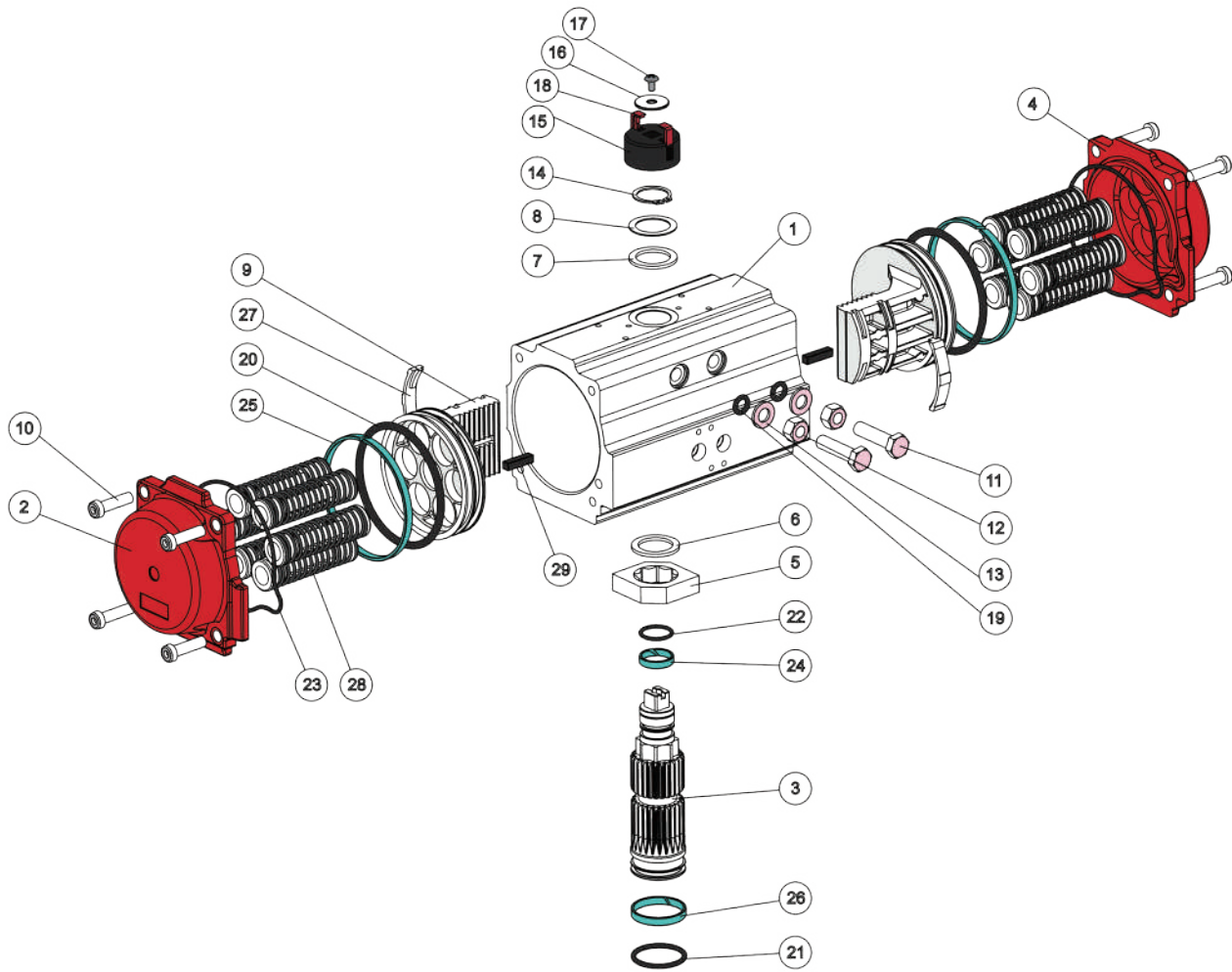

Pneumatic Actuator Components List

Item No.	Part Name	Material	Qty	Item No.	Part Name	Material	Qty	Item No.	Part Name	Material	Qty
1	Cylinder Body	6005-T6 Aluminum Alloy	1	12	Adjustment Nut	304 A2-70 Stainless Steel	2	23	O-ring (End Cap)	NBR/VITON/VMQ	2
2	Left End Cap	ZL104 Aluminum Alloy	1	13	Gasket / Washer	304 A2-70 Stainless Steel	2	24	Upper Bushing	POM (Polyoxymethylene)	1
3	Output Shaft	S45C Medium Carbon Steel	1	14	Spring Retaining Ring	65Mn Spring Steel	1	25	Piston Support Ring	POM (Polyoxymethylene)	2
4	Right End Cap	ZL104 Aluminum Alloy	1	15	Indicator Base	POM (Polyoxymethylene)	1	26	Lower Bushing	POM (Polyoxymethylene)	1
5	Stop Block	S45C Medium Carbon Steel	1	16	Indicator Metal Washe	304 A2-70 Stainless Steel	1	27	Piston Cover Plate	POM (Polyoxymethylene)	2
6	Inner Washer/Spacer	POM (Polyoxymethylene)	1	17	Round Head Phillips Screw	304 A2-70 Stainless Steel	1	28	Spring	55SiCr Spring Steel	0-12
7	Outer Washer/Spacer	POM (Polyoxymethylene)	1	18	Color Indicator / Label	POM (Polyoxymethylene)	2	29	Guide Key	PA6 (Nylon 6)	2
8	Metal Washer	304 A2-70 Stainless Steel	1	19	O-ring (Adjustment Bolt)	NBR/VITON/VMQ	2				
9	Piston	ADC12 Aluminum Alloy	2	20	O-ring (Rack Piston)	NBR/VITON/VMQ	2				
10	End Cap Bolt	304 A2-70 Stainless Steel	8	21	O-ring (Lower Shaft)	NBR/VITON/VMQ	1				
11	Adjustment Bolt	304 A2-70 Stainless Steel	2	22	O-ring (Upper Shaft)	NBR/VITON/VMQ	1				

Air Consumption

type	JEW-032		JEW-050		JEW-065		JEW-075		JEW-085		JEW-095		JEW-110		JEW-125		JEW-140		JEW-160		JEW-190		JEW-210		JEW-240		JEW-270		JEW-300		JEW-350		JEW-400	
	DN	SN	DN	SN	DN	SN	DN	SN	DN	SN	DN	SN	DN	SN	DN	SN	DN	SN	DN	SN	DN	SN	DN	SN	DN	SN	DN	SN	DN	SN	DN	SN	DN	SN
Bore Size (mm)	32	50	65	75	85	95	105	125	140	160	190	210	240	270	300	350	400																	
Opening Volume (L)	0.03	0.1	0.22	0.25	0.45	0.95	1.07	1.47	2.13	3.89	6.16	8.22	12.26	17.35	19.09	27.65	42.81																	
Closing Volume (L)	0.04	0.15	0.26	0.41	0.61	0.98	1.24	1.86	3.08	4.7	8.59	10.95	16.01	24.83	28.23	44.1	62.05																	
Opening Time (s)	0.3	0.3	0.9	0.4	0.9	0.4	0.9	0.9	1	0.9	1.4	0.9	1.4	1.3	2.4	1.3	2.8	2	4.8	2.2	2.4	2.9	3.4	3.2	3.81	4.4	5	5	6	6.2	7.4	7.5	9.6	
Closing Time (s)	0.4	0.4	0.7	0.4	0.8	0.4	0.9	0.9	1.2	1	1.4	1	1.6	1.4	2.4	1.4	3	2.4	4.9	2.6	3	3.8	4.1	3.7	4	4.9	5.5	6	6.8	7.2	8.4	8.5	11	
Weight (kg)	0.47	0.59	1.08	1.2	1.91	2.2	2.41	2.8	3.3	4	5	5.8	6.5	7.95	10.2	12.1	15.1	15.9	21.3	25.6	29.3	33.8	37.7	48.4	54.2	77.76	82	90.6	108	136	147	188	221	284

DN = Double Acting SN=Spring Return

1 Nm = 8.86 Lb-in 1 Lb-in = 0.0115 Kgm 1 Kgm = 9.81 Nm 1 Mpa = 10 Bar
 1 Lb-in = 0.113 Nm 1 Bar = 14.5 Psi 1 Kgm = 86.8 Lb-in 1 Lb-ft = 12 Lb-in

Double Acting Torque Table - JEW Series

Double Acting Torque Output Diagram

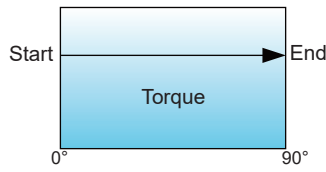

Spring Return Torque Output Diagram

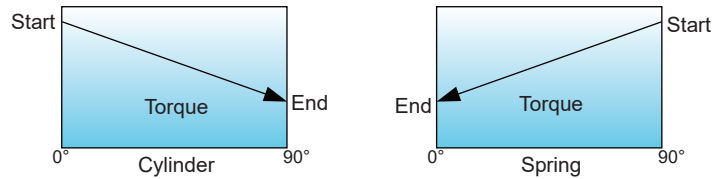

Double Acting Torque (Unit: N·m)

Model	Air Supply Pressure (Unit: Bar)									
	2.5	3	3.5	4	4.5	5	5.5	6	7	8
JEW-032	2.9	3.4	4	4.6	5.3	5.9	6.5	7.1	8.3	9.5
JEW-040	5.7	6.9	8.1	9.4	10.6	11.8	13	14.3	16.7	19.2
JEW-050	9.4	11.3	13.2	15.1	17	18.8	20.7	22.6	26.4	30.2
JEW-065	19.1	22.9	26.7	30.6	34.4	38.2	42	45.9	53.5	61.2
JEW-075	25.2	30.2	35.3	40.3	45.3	50.4	55.4	60.4	70.5	80.6
JEW-085	40.8	49	57.2	65.4	73.5	81.7	89.9	98.1	114.4	130.7
JEW-095	61.2	73.5	85.7	100	110.2	122.5	134.7	147	171.5	196
JEW-110	83.1	99.7	116.4	133	149.6	166.2	182.9	199.5	232.7	266
JEW-125	132.5	159	185.5	212	238.6	265.1	291.6	318.1	371.1	424.1
JEW-140	219.3	263.2	307.1	351	394.9	438.7	482.6	526.4	614.2	702
JEW-160	334.2	401.1	468	534.8	601.7	668.5	735.4	802.2	935.9	1069.6
JEW-190	505	606	707	808	909	1010	1111	1212	1414	1616.1
JEW-210	658	789.7	921.3	1052.9	1184.5	1316.1	1447.8	1579.4	1842.6	2105.8
JEW-240	967	1160.3	1353.7	1547.1	1740.5	1934	2127.3	2320.7	2707.5	3094.3
JEW-270	1468.6	1762.3	2056	2349.7	2643.4	2937.2	3230.9	3524.6	4112	4699.5
JEW-300	1678.6	2029.4	2379.3	2729.2	3079.1	3429	3778.9	4128.8	4828.5	5528.3
JEW-350	2492.5	3011.8	3531.1	4050.4	4569.6	5088.9	5608.2	6127.5	7166	8204.6
JEW-400	3798.1	4589.4	5380.7	6172	6963.3	7754.5	8545.8	9337.1	10919.7	12502.2

Spring Return Torque Table - JEV Series

Spring Return Torque (Unit: N-m)																						
Model	Air Supply Pressure (Unit: Bar)																				Spring Return	
	2.5		3		3.5		4		4.5		5		5.5		6		7		8			
	0°	90°	0°	90°	0°	90°	0°	90°	0°	90°	0°	90°	0°	90°	0°	90°	0°	90°	0°	90°	90°	0°
JEV-050-05	5.8	3.7	7.7	5.6	9.6	7.5	11.5	9.4	13.4	11.3	15.2	13.1	17.1	15	19	16.9	22.8	20.7	26.6	24.5	5.7	3.6
JEV-050-06	5.1	2.6	7	4.5	8.9	6.4	10.8	8.3	12.7	10.2	14.5	12	16.4	13.9	18.3	15.8	22.1	19.6	25.9	23.4	6.8	4.3
JEV-050-07			6.3	1.4	8.2	5.2	10.1	7.1	12	9	13.8	10.8	15.7	12.7	17.6	14.6	21.4	18.4	25.2	22.2	8	5
JEV-050-08					7.4	4.1	9.3	6	11.2	7.9	13	9.7	14.9	11.6	16.8	13.5	20.6	17.3	24.4	21.1	9.1	5.8
JEV-050-09							8.6	4.8	10.5	6.7	12.3	8.5	14.2	10.4	16.1	12.3	19.9	16.1	23.7	19.9	10.3	6.5
JEV-050-10									9.8	5.6	11.6	7.4	13.5	9.3	15.4	11.2	19.2	15	23	18.8	11.4	7.2
JEV-050-11											10.9	6.3	12.8	8.2	14.7	10.1	18.5	13.9	22.3	17.7	12.5	7.9
JEV-050-12													12.1	7	14	8.9	17.8	12.7	21.6	16.5	13.7	8.6
JEV-065-05	11.9	7.9	15.7	11.7	19.5	15.5	23.4	19.4	27.2	23.2	31	27	34.8	30.8	38.7	34.7	46.3	42.3	54	50	11.2	7.2
JEV-065-06	10.2	5.7	14.3	9.5	18.1	13.3	22	17.2	25.8	21	29.6	24.8	33.4	28.6	37.3	32.5	44.9	40.1	52.6	47.8	13.4	8.6
JEV-065-07			12.8	7.2	16.6	11	20.5	14.9	24.3	18.7	28.1	22.5	31.9	26.3	35.8	30.2	43.4	37.8	51.1	45.5	15.7	10.1
JEV-065-08					15.2	8.8	19.1	12.7	22.9	16.5	26.7	20.3	30.5	24.1	34.4	28	42	35.6	49.7	43.3	17.9	11.5
JEV-065-09							17.6	10.4	21.4	14.2	25.2	18	29	21.8	32.9	25.7	40.5	33.3	48.2	41	20.2	13
JEV-065-10									20	12	23.8	15.8	27.6	19.6	31.5	23.5	39.1	31.1	46.8	38.8	22.4	14.4
JEV-065-11											22.4	13.6	26.2	17.4	30.1	21.3	37.7	28.9	45.4	36.6	24.6	15.8
JEV-065-12													24.7	15.1	28.6	19	36.2	26.6	43.9	34.3	26.9	17.3
JEV-075-05	16	9.1	21	14.1	26.1	19.2	31.1	24.2	36.1	29.2	41.2	34.3	46.2	39.3	51.2	44.3	61.3	54.4	71.4	64.5	16.1	9.2
JEV-075-06	14.2	5.9	19.2	10.9	24.3	16	29.3	21	34.3	26	39.4	31.1	44.4	36.1	49.4	41.1	59.5	51.2	69.6	61.3	19.3	11
JEV-075-07			17.3	7.7	22.4	12.8	27.4	17.8	32.4	22.8	37.5	27.9	42.5	32.9	47.5	37.9	57.6	48	67.7	58.1	22.5	12.9
JEV-075-08					20.6	9.5	25.6	14.5	30.6	19.5	35.7	24.6	40.7	29.6	45.7	34.6	55.8	44.7	65.9	54.8	25.8	14.7
JEV-075-09							23.7	11.3	28.7	16.3	33.8	21.4	38.8	26.4	43.8	31.4	53.9	41.5	64	51.6	29	16.6
JEV-075-10									26.9	13.1	32	18.2	37	23.2	42	28.2	52.1	38.3	62.2	48.4	32.2	18.4
JEV-075-11											30.2	15	35.2	20	40.2	25	50.3	35.1	60.4	45.2	35.4	20.2
JEV-075-12													33.3	16.8	38.3	21.8	48.4	31.9	58.5	42	38.6	22.1
JEV-085-05	25.8	14.8	34	23	42.2	31.2	50.4	39.4	58.5	47.5	66.7	55.7	74.9	63.9	83.1	72.1	99.4	88.4	115.7	104.7	26	15
JEV-085-06	22.8	9.6	31	17.8	39.2	26	47.4	34.2	55.5	42.3	63.7	50.5	71.9	58.7	80.1	66.9	96.4	83.2	112.7	99.5	31.2	18
JEV-085-07			28	12.6	36.2	20.8	44.4	29	52.5	37.1	60.7	45.3	68.9	53.5	77.1	61.7	93.4	78	109.7	94.3	36.4	21
JEV-085-08					33.2	15.6	41.4	23.8	49.5	31.9	57.7	40.1	65.9	48.3	74.1	56.5	90.4	72.8	106.7	89.1	41.6	24
JEV-085-09							38.4	18.6	46.5	26.7	54.7	34.9	62.9	43.1	71.1	51.3	87.4	67.6	103.7	83.9	46.8	27
JEV-085-10									43.5	21.5	51.7	29.7	59.9	37.9	68.1	46.1	84.4	62.4	100.7	78.7	52	30
JEV-085-11											48.7	24.5	56.9	32.7	65.1	40.9	81.4	57.2	97.7	73.5	57.2	33
JEV-085-12													53.9	27.5	62.1	35.7	78.4	52	94.7	68.3	62.4	36
JEV-095-05	36.7	24.5	49	36.8	61.2	49	75.5	63.3	85.7	73.5	98	85.8	110.2	98	122.5	110.3	147	134.8	171.5	159.3	36.7	24.5
JEV-095-06	31.8	17.2	44.1	29.5	56.3	41.7	70.6	56	80.8	66.2	93.1	78.5	105.3	90.7	117.6	103	142.1	127.5	166.6	152	44	29.4
JEV-095-07			39.2	22.1	51.4	34.3	65.7	48.6	75.9	58.8	88.2	71.1	100.4	83.3	112.7	95.6	137.2	120.1	161.7	144.6	51.4	34.3
JEV-095-08					46.5	27	60.8	41.3	71	51.5	83.3	63.8	95.5	76	107.8	88.3	132.3	112.8	156.8	137.3	58.7	39.2
JEV-095-09							55.9	33.9	66.1	44.1	78.4	56.4	90.6	68.6	102.9	80.9	127.4	105.4	151.9	129.9	66.1	44.1
JEV-095-10									61.2	36.8	73.5	49.1	85.7	61.3	98	73.6	122.5	98.1	147	122.6	73.4	49
JEV-095-11											68.6	41.8	80.8	54	93.1	66.3	117.6	90.8	142.1	115.3	80.7	53.9
JEV-095-12													75.9	46.6	88.2	58.9	112.7	83.4	137.2	107.9	88.1	58.8
JEV-110-05	50.8	31.7	67.4	48.3	84.1	65	100.7	81.6	117.3	98.2	133.9	114.8	150.6	131.5	167.2	148.1	200.4	181.3	233.7	214.6	51.4	32.3
JEV-110-06	44.3	21.4	60.9	38	77.6	54.7	94.2	71.3	110.8	87.9	127.4	104.5	144.1	121.2	160.7	137.8	193.9	171	227.2	204.3	61.7	38.8
JEV-110-07			54.5	27.7	71.2	44.4	87.8	61	104.4	77.6	121	94.2	137.7	110.9	154.3	127.5	187.5	160.7	220.8	194	72	45.2
JEV-110-08					64.7	34.2	81.3	50.8	97.9	67.4	114.5	84	131.2	100.7	147.8	117.3	181	150.5	214.3	183.8	82.2	51.7
JEV-110-09							74.9	40.5	91.5	57.1	108.1	73.7	124.8	90.4	141.4	107	174.6	140.2	207.9	173.5	92.5	58.1
JEV-110-10									85	46.8	101.6	63.4	118.3	80.1	134.9	96.7	161.6	129.9	201.4	163.2	102.8	64.6
JEV-110-11											95.1	53.1	111.8	69.8	128.4	86.4	161.6	119.6	194.9	152.9	113.1	71.1
JEV-110-12													105.4	59.5	122	76.1	155.2	109.3	188.5	142.6	123.4	77.5

Spring Return Torque Table - JEV Series

Model	Spring Return Torque (N·m)																				Spring Return	
	Air Supply Pressure (Unit: Bar)																					
	2.5		3		3.5		4		4.5		5		5.5		6		7		8			
0°	90°	0°	90°	0°	90°	0°	90°	0°	90°	0°	90°	0°	90°	0°	90°	0°	90°	0°	90°	90°	0°	
JEV-125-05	78.5	53.9	105	80.4	131.5	106.9	158	133.4	184.6	160	211.1	186.5	237.6	213	264.1	239.5	317.1	292.5	370.1	345.5	78.6	54
JEV-125-06	67.7	38.2	94.2	64.7	120.7	91.2	147.2	117.7	173.8	144.3	200.3	170.8	226.8	197.3	253.3	223.8	306.3	276.8	359.3	329.8	94.3	64.8
JEV-125-07			83.4	49	109.9	75.5	136.4	102	163	128.6	189.5	155.1	216	181.6	242.5	208.1	295.5	261.1	348.5	314.1	110	75.6
JEV-125-08					99.1	59.7	125.6	86.2	152.2	112.8	178.7	139.3	205.2	165.8	231.7	192.3	284.7	245.3	337.7	298.3	125.8	86.4
JEV-125-09							114.8	70.5	141.4	97.1	167.9	123.6	194.4	150.1	220.9	176.6	273.9	229.6	326.9	282.6	141.5	97.2
JEV-125-10									130.6	81.4	157.1	107.9	183.6	134.4	210.1	160.9	263.1	213.9	316.1	266.9	157.2	108
JEV-125-11											146.3	92.2	172.8	118.7	199.3	145.2	252.3	198.2	305.3	251.2	172.9	118.8
JEV-125-12													162	103	188.5	129.5	241.5	182.5	294.5	235.5	188.6	129.6
JEV-140-05	133.8	85.4	177.7	129.3	221.6	173.2	265.5	217.1	309.4	261	353.2	304.8	397.1	348.7	440.9	392.5	528.7	480.3	616.5	568.1	133.9	85.5
JEV-140-06	116.7	58.6	160.6	102.5	204.5	146.4	248.4	190.3	292.3	234.2	336.1	278	380	321.9	423.8	365.7	511.6	453.5	599.4	541.3	160.7	102.6
JEV-140-07			143.5	75.7	187.4	119.6	231.3	163.5	275.2	207.4	319	251.2	362.9	395.1	406.7	338.9	494.5	426.7	582.3	514.5	187.5	119.7
JEV-140-08					170.3	92.9	214.2	136.8	258.1	180.7	301.9	224.5	345.8	268.4	389.6	312.2	477.4	400	565.2	487.8	214.2	136.8
JEV-140-09							197.1	110	241	153.9	284.8	197.7	328.7	241.6	372.5	285.4	460.3	373.2	548.1	461	241	153.9
JEV-140-10									223.9	127.1	267.7	170.9	311.6	214.8	355.4	258.6	443.2	346.4	531	434.2	267.8	171
JEV-140-11											250.6	144.1	294.5	188	338.3	231.8	426.1	319.6	513.9	407.4	294.6	188.1
JEV-140-12													277.4	161.2	321.2	205	409	292.8	496.8	380.6	321.4	205.2
JEV-160-05	208.7	125.6	275.6	192.5	342.5	259.4	409.3	326.2	476.2	393.1	543	459.9	609.9	526.8	676.7	593.6	810.4	727.3	944.1	861	208.6	125.5
JEV-160-06	183.6	83.9	250.5	150.8	317.4	217.7	384.2	284.5	451.1	351.4	517.9	418.2	584.8	485.1	651.6	551.9	785.3	686.6	919	819.3	250.3	150.6
JEV-160-07			225.4	109.1	292.3	176	359.1	242.8	426	309.7	492.8	376.5	559.7	443.4	626.5	510.2	760.2	643.9	893.9	777.6	292	175.7
JEV-160-08					267.2	134.2	334	201	400.9	267.9	467.7	334.7	534.6	401.6	601.4	468.4	735.1	602.1	868.8	735.8	333.8	200.8
JEV-160-09							308.9	159.3	375.8	226.2	442.6	293	509.5	359.9	576.3	426.7	710	560.4	843.7	694.1	375.5	225.9
JEV-160-10									350.7	184.5	417.5	251.3	484.4	318.2	551.2	385	684.9	518.7	818.6	652.4	417.2	251
JEV-160-11											392.4	209.6	459.3	276.5	526.1	343.3	659.8	477	793.5	610.7	458.9	276.1
JEV-160-12													434.2	234.8	501	301.6	634.7	435.3	768.4	569	500.6	301.2
JEV-190-05	309	195	410	296	511	397	612	498	713	599	814	700	915	801	1016	902	1218	1104	1420.1	1306.1	310	196
JEV-190-06	269.8	133	370.8	234	471.8	335	572.8	436	673.8	537	774	638	875.8	739	976.8	840	1178.8	1042	1380.9	1244.1	372	235.2
JEV-190-07			331.6	172	432.6	273	533.6	374	634.6	475	735.6	576	836.6	677	937.6	778	1139.6	980	1341.7	1182.1	434	274.4
JEV-190-08					393.4	211	494.4	312	595.4	413	696.4	514	797.4	615	898.4	716	1100.4	918	1302.5	1120.1	496	313.6
JEV-190-09							455.2	250	556.2	351	657.2	452	758.2	553	859.2	654	1061.2	856	1263.3	1058.1	558	352.8
JEV-190-10									517	289	618	390	719	491	820	592	1022	794	1224.1	996.1	620	392
JEV-190-11											578.8	328	679.8	429	780.8	530	982.8	732	1184.9	934.1	682	431.2
JEV-190-12													640.6	367	741.6	468	943.6	670	1145.7	872.1	744	470.4
JEV-210-05	380	278	511.7	409.7	643.3	541.3	774.9	672.9	906.5	804.5	1038.1	936.1	1169.8	1067.8	1301.4	1199.4	1564.6	1462.6	1827.8	1725.8	380	278
JEV-210-06	324.4	202	456.1	333.7	587.7	465.3	719.3	596.9	850.9	728.5	982.5	860.1	1114.2	991.8	1245.8	1123.4	1509	1386.6	1772.2	1649.8	456	333.6
JEV-210-07			400.5	257.7	532.1	389.3	663.7	520.9	795.3	652.5	926.9	784.1	1058.6	915.8	1190.2	1047.4	1453.4	1310.6	1716.6	1573.8	532	389.2
JEV-210-08					476.5	313.3	608.1	444.9	739.7	576.5	871.3	708.1	1003	839.8	1134.6	971.4	1397.8	1234.6	1661	1497.8	608	444.8
JEV-210-09							552.5	368.9	684.1	500.5	815.7	632.1	947.4	763.8	1079	895.4	1342.2	1158.6	1605.4	1421.8	684	500.4
JEV-210-10									628.5	424.5	760.1	556.1	891.8	687.8	1023.4	819.4	1286.6	1082.6	1549.8	1345.8	760	556
JEV-210-11											704.5	480.1	836.2	611.8	967.8	743.4	1231	1006.6	1494.2	1269.8	836	611.6
JEV-210-12													780.6	535.8	912.2	667.4	1175.4	930.6	1438.6	1193.8	912	667.2
JEV-240-05	593	373.9	786.3	567.2	979.7	760.6	1173.1	954	1366.5	1147.4	1560	1340.9	1753.3	1534.2	1946.7	1727.6	2333.5	2114.4	2720.3	2501.2	593.1	374
JEV-240-06	518.2	255.3	711.5	448.6	904.9	642	1098.3	835.4	1291.7	1028.8	1485.2	1222.3	1678.5	1415.6	1871.9	1609	2258.7	1995.8	2645.5	2382.6	711.7	448.8
JEV-240-07			636.7	330	830.1	523.4	1023.5	716.8	1216.9	910.2	1410.4	1103.7	1603.7	1297	1797.1	1490.4	2183.9	1877.2	2570.7	2264	830.3	523.6
JEV-240-08					755.3	404.7	948.7	598.1	1142.1	791.5	1335.6	985	1528.9	1178.3	1722.3	1371.7	2109.1	1758.5	2495.9	2145.3	949	598.4
JEV-240-09							873.9	479.5	1067.3	672.9	1260.8	866.4	1454.1	1059.7	1647.5	1253.1	2034.3	1639.9	2421.1	2026.7	1067.6	673.2
JEV-240-10									992.5	554.3	1186	747.8	1379.3	941.1	1572.7	1134.5	1959.5	1521.3	2346.3	1908.1	1186.2	748
JEV-240-11											1111.2	629.2	1304.5	822.5	1497.9	1015.9	1884.7	1402.7	2271.5	1789.5	1304.8	822.8
JEV-240-12													1229.7	703.9	1423.1	897.3	1809.9	1284.1	2196.7	1670.9	1423.4	897.6
JEV-270-05	853	615.8	1146.7	909.5	1440.4	1203.2	1734.1	1496.9	2027.8	1790.6	2321.6	2084.4	2615.3	2378.1	2909	2671.8	3496.4	3259.2	4083.9	3846.7	852.8	615.6
JEV-270-06	729.9	445.2	1023.6	738.9	1317.3	1032.6	1611	1326.3	1904.7	1620	2198.5	1913.8	2492.2	2207.5	2785.9	2501.2	3373.3	3088.6	3960.8	3676.1	1023.4	738.7
JEV-270-07			900.5	568.4	1194.2	862.1	1487.9	1155.8	1781.6	1449.5	2075.4	1743.3	2369.1	2037	2662.8	2330.7	3250.2	2918.1	3837.7	3505.6	1193.9	861.8
JEV-270-08					1071	691.5	1364.7	985.2	1658.4	1278.9	1952.2	1572.7	2245.9	1866.4	2539.6	2160.1	3127	2747.5	3714.5	3335	1364.5	985
JEV-270-09							1241.6	814.7	1535.3	1108.4	1829.1	1402.2	2122.8	1695.9	2416.5	1989.6	3003.9	2577	3591.4	3164.5	1535	1108.1
JEV-270-10									1412.2	937.8	1706	1231.6	1999.7	1525.3	2293.4	1819	2880.8	2406.4	3468.3	2993.9	1705.6	1231.2
JEV-270-11											1582.9	1061	1876.6	1354.7	2170.3	1648.4	2757.7	2235.8	3345.2	2823.3	1876.2	1354.3
JEV-270-12													1753.5	1184.2	2047.2	1477.9	2634.6	2065.3	3222.1	2652.8	2046.7	1477.4
JEV-300-05	987.5	646.7	1338.3	997.5	1688.2	1347.4	2038.1	1697.3	2388	2047.2	2737.9	2397.1	3087.8	2747	3437.7	3096.9	4137.4	3796.6	4837.2	4496.4	1031.9	691.1
JEV-300-06	849.3	440.3	1200.1	791.1	1550																	

Installation

Applicable for 050-270

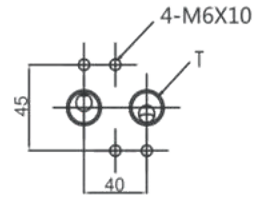
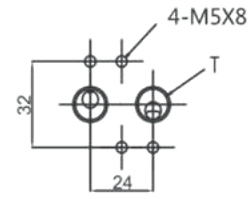
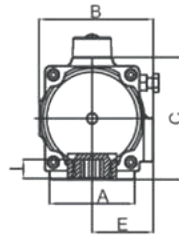
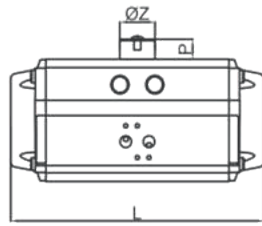

Applicable to 300, 350

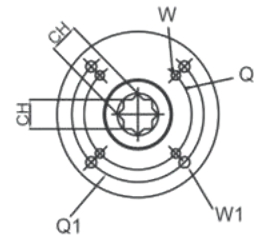
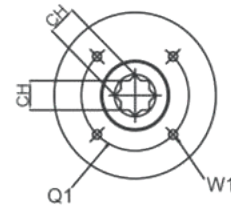
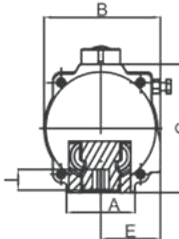
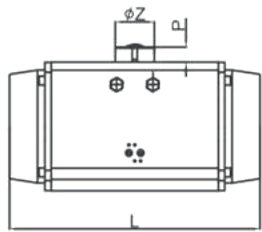

Applicable to 400

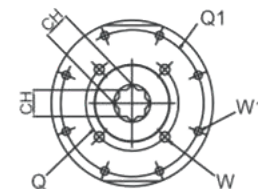
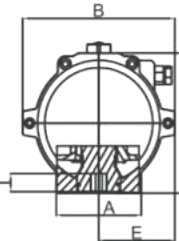
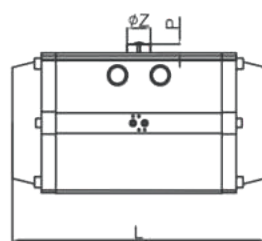

Pneumatic Actuator Dimensions (Unit: mm)

Model	A	B	C	L	E	F	P	Z	N	I	Flange Type	Q	Q1	W	W1	Ch	T
50	46	71	70	151	41.5	80	20	40	10	12	F03/F05	36	50	M5x7.5	M6x9	11x11	G1/4"
65	64	84.5	89	168	46.5	80	20	40	10	16	F05/F07	50	70	M6x9	M8x12	14x14	G1/4"
75	68	98.8	100	182	55	80	20	40	14	16	F05/F07	50	70	M6x9	M8x12	14x14	G1/4"
85	68	108.5	113	210	59.5	80	20	40	14	19	F05/F07	50	70	M6x9	M8x12	17x17	G1/4"
95	88	117.7	123	261.8	63	80	20	40	14	19	F05/F07	50	70	M6x9	M8x12	17x17	G1/4"
110	93	132	136	285.2	73	80	20	40	14	19	F07/F10	70	102	M8x12	M10x15	17x17	G1/4"
125	96	152	159	320	81	80/130	30	56	22	25	F07/F10	70	102	M8x12	M10x15	22x22	G1/4"
140	110	172	178	401	91	80/130	30	56	22	31	F10/F12	102	125	M10x15	M12x18	27x27	G1/4"
160	112	189	200	459	100	80/130	30	56	22	31	F10/F12	102	125	M10x15	M12x18	27x27	G1/4"
190	136	217	232	495	112	130	30	56	22	41	F10/F14	102	140	M10x15	M16x24	36x36	G1/4"
210	140	236	255	529	122	130	30	80	32.5	40	F14	-	140	-	M16x24	36x36	G1/4"
240	160	268.5	292	618	139	130	30	80	32.5	50	F16	-	165	-	M20x25	46x46	G1/2"
270	160	296	331	737	151	130	30	80	32.5	50	F16	-	165	-	M20x25	46x46	G1/2"
300	180	335	354	784	173	130	30	80	32.5	50	F16	-	165	-	M20x25	46x46	G1/2"
350	270	385	410	845	195	130	30	80	32.5	50	F16/F25	165	254	M20x25	M16x24	46x46	G1/2"
400	290	520	466	956	260	130	30	80	32.5	60	F25	-	254	-	M16x24	55x55	G1/2"

HOW TO ORDER

JEV → A → B → C → D → E

Ex: **JEV** → JEV → 095 → G → R → 08

A Type	B Size	C Air Supply Port
JEW	32 190	G: (G Thread, BSPP, Parallel, 55°C)
JEV	50 210	P: (PT, Rc, BSPT, Tapered, 55°C)
	65 240	N: (NPT, ANSI, Tapered, 60°C)
	075 270	
	085 300	
Note:	095 350	
JEW: Double Acting	110 400	
JEV: Spring Return	125	
	140	
	160	

D O-Ring	E Number of Springs
R: Normal Temp: RT-NBR-70	04
L: Low Temp: LT-SL-70	05
H: High Temp: HT-FKM-75	06
	07
	08
Note:	09
Normal Temp: NBR(-15~+80°C)	10
Low Temp: Silicon(-40~+80°C)	11
High Temp: Viton (-15~+150°C)	12

Notes

- Standard rotation for both double acting and spring return types is clockwise to close.
- The standard operating temperature range for seals is -18°C to 80°C. For special environmental requirements such as high or low temperatures, seals made of corresponding materials can be selected.
- For high and low-temperature environments, Viton and Silicone O-rings are provided respectively, used in conjunction with special lubricants.
- For various parameters of standard products, please refer to the relevant sections of this manual. Our company can also provide special customized services based on standard products; please feel free to contact our sales engineers.
- All specifications can be provided with 304 or 316 stainless steel gear output shafts upon request.

Example Descriptions

< Example 1 > JEW-110-P-R

JEW is defined as the code for double acting, 110 is the cylinder pneumatic actuator model number, P is the code for air supply inlet/outlet specification PT(Rc) thread BSPT, R defines the applicable temperature range for the cylinder seals.

< Example 2 > JEV-095-G-R-08

JEV is defined as the code for spring return, 095 is the cylinder pneumatic actuator model number, G is the code for air supply inlet/outlet specification G thread BSPP, R defines the applicable temperature range for the cylinder seals, and finally select the required number of cylinder installation springs.



JDV CONTROL VALVES

TPEX 6843

HEADQUARTERS

📍 NO. 6-1, QINGNIAN RD., YANGMEI DIST., TAOYUAN CITY 326013, TAIWAN

☎ +886-3-4965066

📠 +886-3-4963526

✉ sales@jdv.com.tw

🌐 www.jdv.com.tw



JDV Website



Android –
ipad & iphone



IOS –
ipad & iphone



LINE OA

  jdv.valves

 @jdv.valves

 jdv_valves